

A PLAN VIEW
JUDGES BENCH

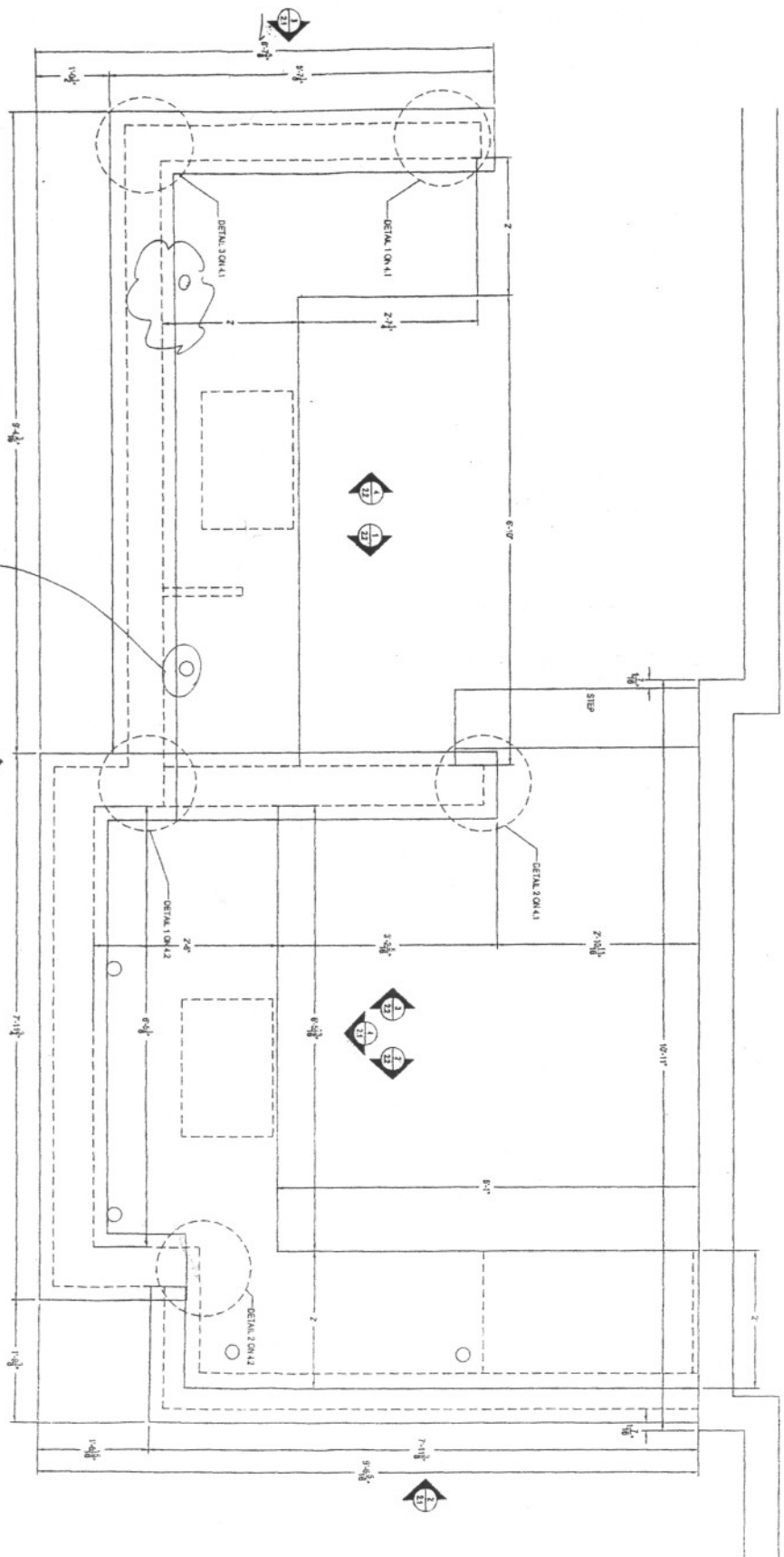

Verify location of Ovens

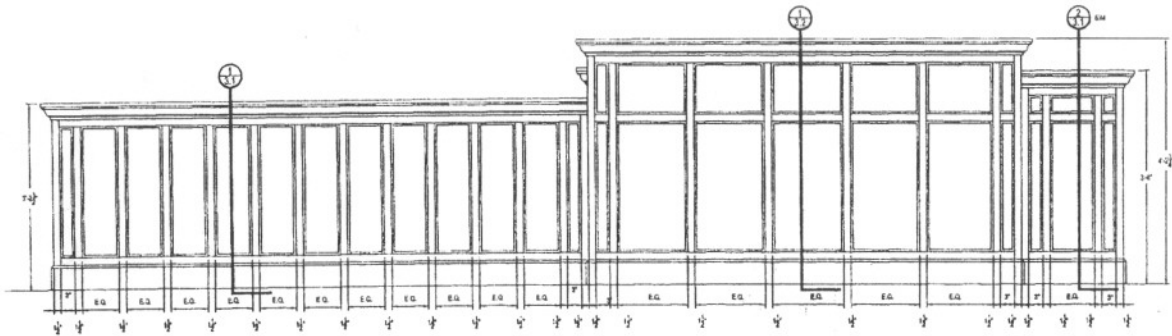

1 ELEVATION
COURTROOM 2
ROOM 107

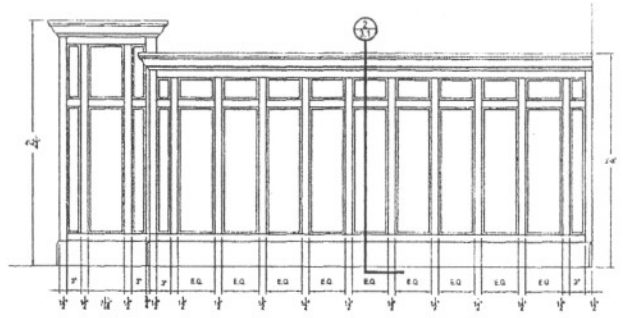

2 ELEVATION
COURTROOM 2
ROOM 107

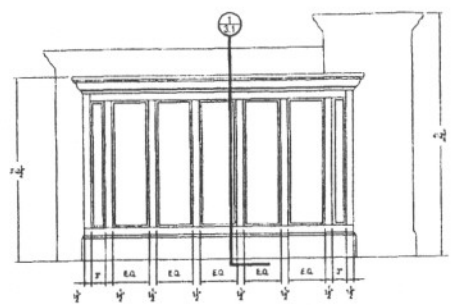

3 ELEVATION
COURTROOM 2
ROOM 107

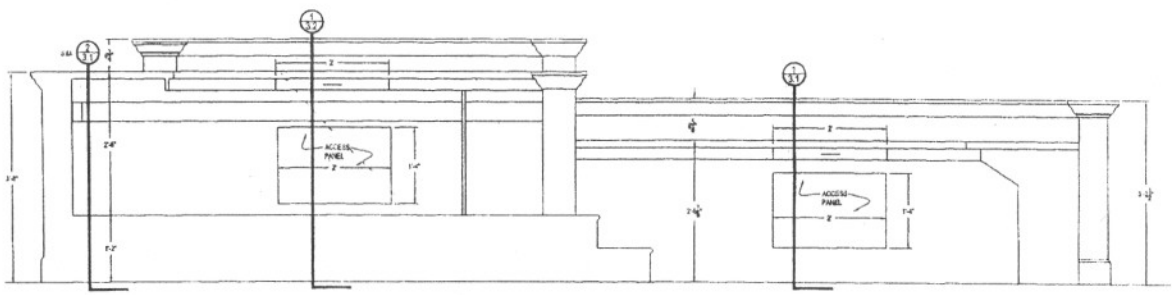

4 ELEVATION
COURTROOM 2
ROOM 107

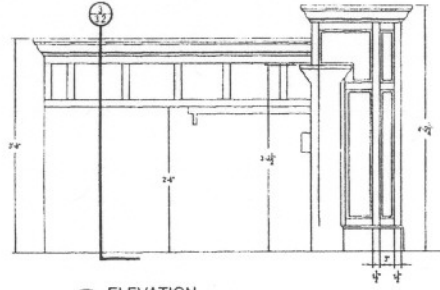

① ELEVATION
COURTROOM 2
ROOM 107

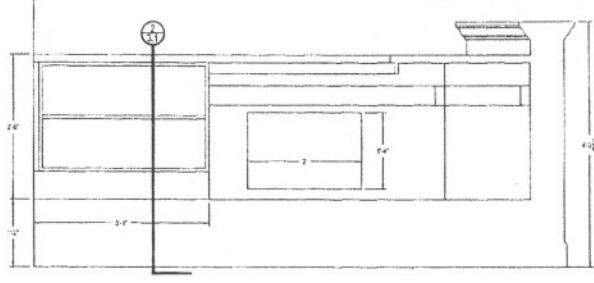

② ELEVATION
COURTROOM 2
ROOM 107

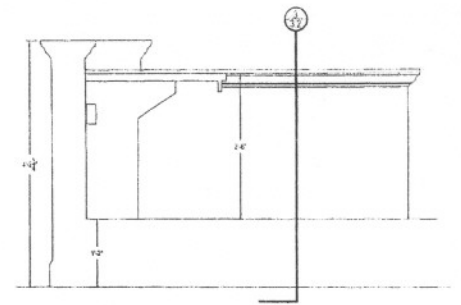

③ ELEVATION
COURTROOM 2
ROOM 107

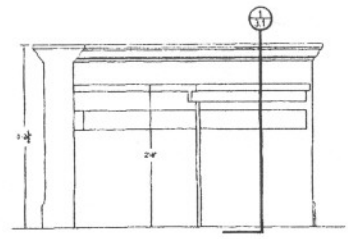

④ ELEVATION
COURTROOM 2
ROOM 107



A PLAN VIEW
GALLERY RAIL
SCALE 1/2" = 1'-0"

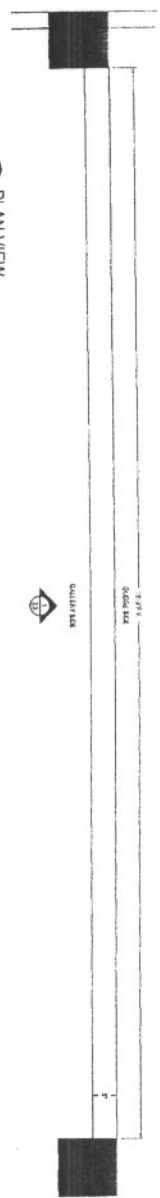

B PLAN VIEW
GALLERY RAIL

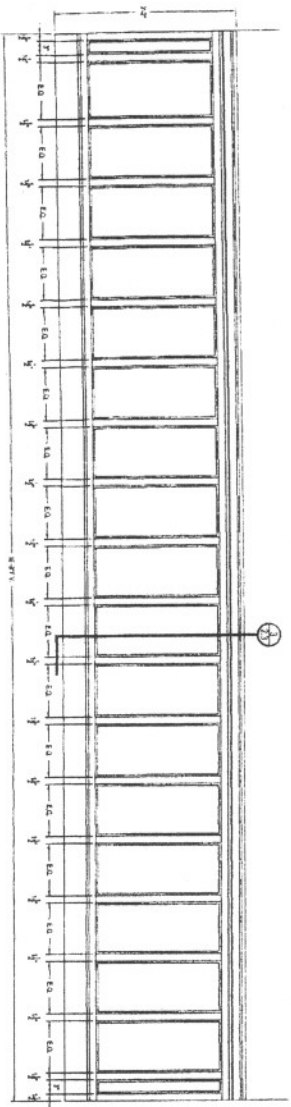

1 ELEVATION
GALLERY RAIL



C PLAN VIEW
GALLERY RAIL

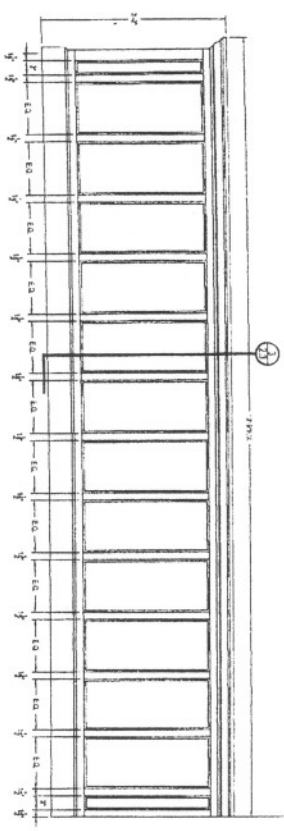

2 ELEVATION
GALLERY RAIL

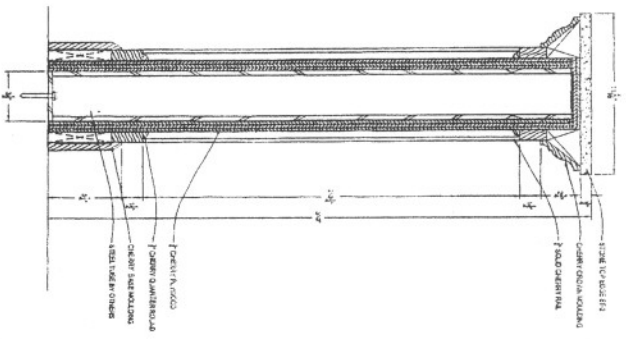

3 SECTION
GALLERY RAIL
SCALE 3/4" = 1'-0"

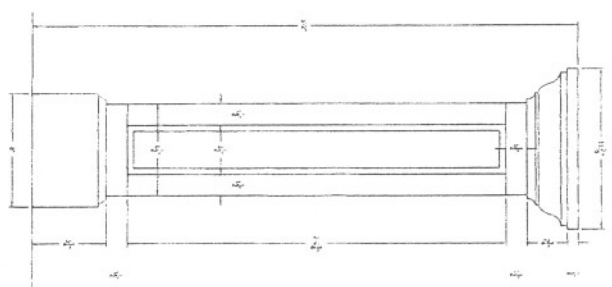

4 ELEVATION
GALLERY RAIL
SCALE 3/4" = 1'-0"

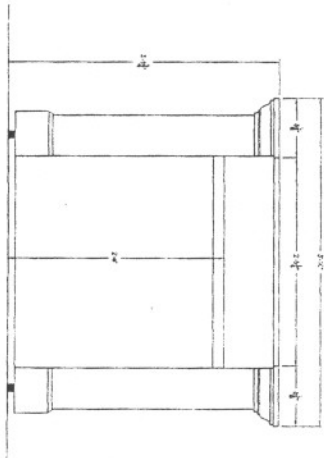

1 ELEVATION
WITNESS STAND

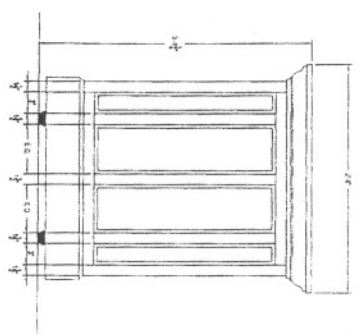

2 ELEVATION
WITNESS STAND

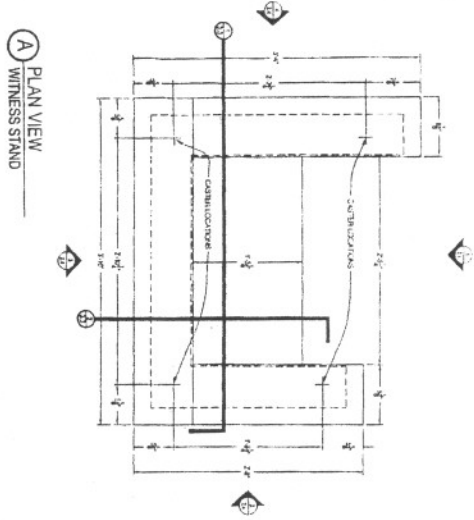

A PLAN VIEW
WITNESS STAND

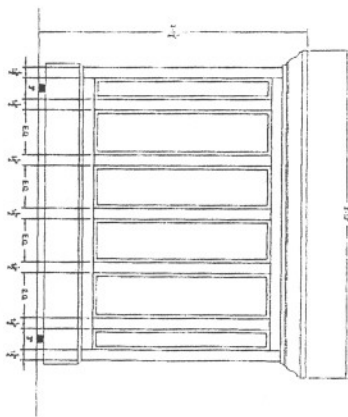

3 ELEVATION
WITNESS STAND

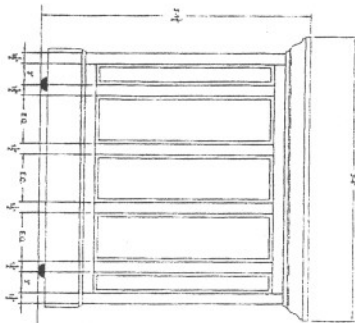

4 ELEVATION
WITNESS STAND

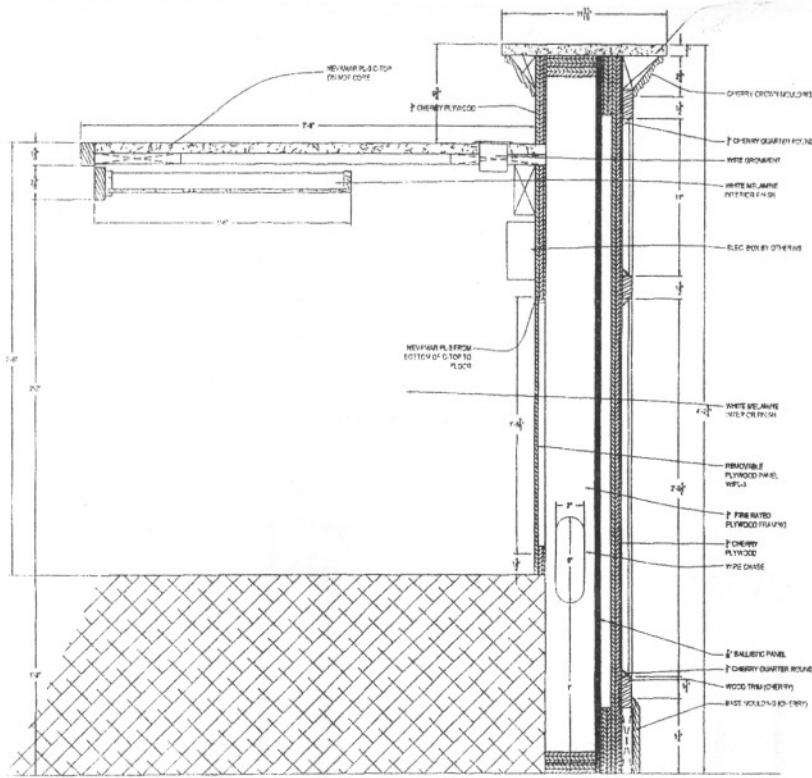

1 SECTION
COURTROOM 2

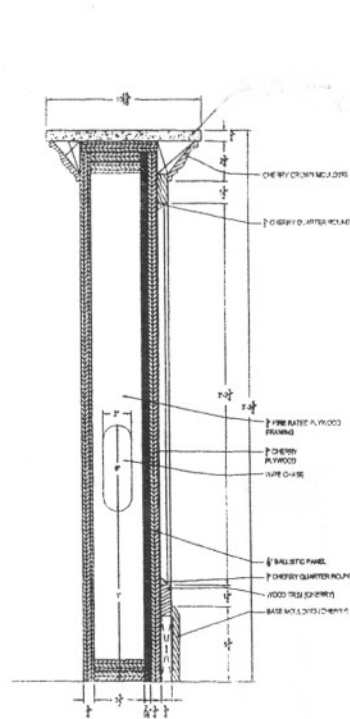

2 SECTION
COURTROOM 2

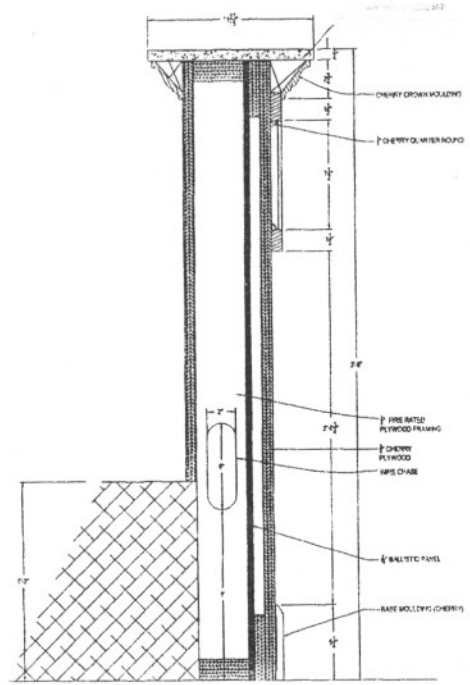

3 SECTION
COURTROOM 2